

Chapter 4

Using the interactive pen display

Turning the interactive pen display on and off	22
Using the cordless pen	23
Cordless pen components	24
Pen color buttons	25
Customizing button actions on the cordless pen	25
Available pen button actions	25
Assigning button actions on the cordless pen	26
Writing or drawing digital ink	27
Erasing digital ink	28
Using gestures	29
Using single finger gestures	29
Using multi-finger gestures	30
Working with SMART Ink	31
Starting SMART Ink manually	32
Using the dynamic toolbar	32
About SMART Ink settings	34
Using SMART Ink with Microsoft Office	34
Writing or drawing in PDF files	35
Other SMART Ink resources	35

This chapter explains the SMART Podium interactive pen display's basic operation, including how to write and erase digital notes and how to work with SMART Ink and Ink Aware applications.

Turning the interactive pen display on and off

This picture and table describe the SMART Podium display's power controls and status LEDs.

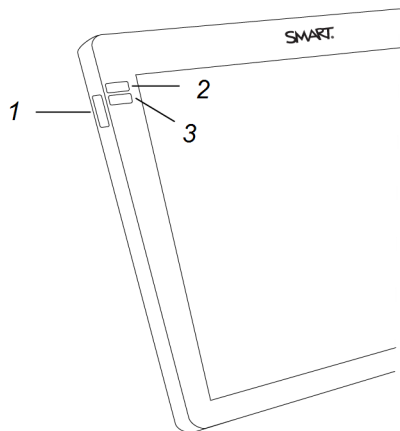

No.	Component	Description
1	Power button	Turns the interactive pen display on or off
2	Power LED	The Power LED is: <ul style="list-style-type: none">• Blue when the pen display is turned on and receiving a video signal.• Orange when the pen display is turned on but not receiving a video signal.• Off, when the interactive pen display is turned off.
3	Status LED	The Status LED lights blue when the pen nib comes close to the screen surface or when you press the pen button

▶ To turn the interactive pen display on

Press the **Power** button on the front left side of the interactive pen display.

NOTE

The interactive pen display turns off automatically after one minute without video input.

▶ To turn the interactive pen display off



Press the **Power** button on the front left side of the interactive pen display.

Using the cordless pen

You can use the battery free cordless pen to write notes and draw on the display's screen in digital ink and activate settings you assign to the pen's rocker button.

Hold the cordless pen as you would hold any normal pen or pencil. As you work with the interactive pen display, you can rest your hand on the display screen, just as if it were a sheet of paper. You can tilt the cordless pen in any way that feels most comfortable for writing or drawing.

IMPORTANT

You can write notes over applications and your desktop only if SMART Product Drivers is running on your computer. If the SMART Board icon in the Windows notification area or Mac Dock has a small red x in the lower right corner  or , SMART Product Drivers is not running on your computer or the display is not connected properly.

TIPS

- You can access SMART Settings to assign actions to your pen buttons, such as opening SMART Notebook software or advancing the slide in a Microsoft PowerPoint® presentation. To learn more, see *Customizing button actions on the cordless pen* on page 25.
- Store the cordless pen in the pen holder when it's not in use. You can attach the pen holder to either side of the display.
- You can use SMART Notebook software or SMART Meeting Pro software to make your presentations interactive and dynamic. For more details on about you can accomplish with SMART Notebook software or SMART Meeting Pro software, see the SMART software's online Help.

Cordless pen components

This illustration shows the cordless pen's components.

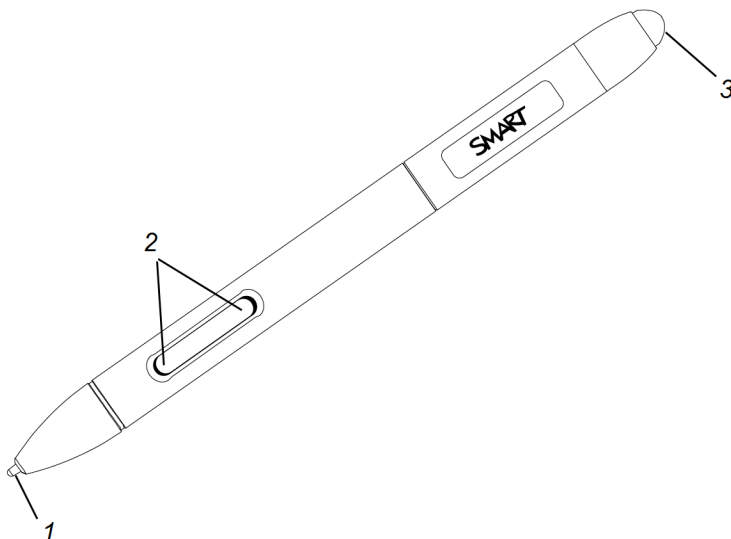

No.	Component	Description
1	Pen nib	Press a Pen Color button, and then touch the pen nib to the screen surface to write with digital ink. CAUTION Replace a cordless pen nib when the nib wears down. If a pen nib wears down too far, you might scratch or damage the interactive pen display surface. Extra nibs are supplied with the interactive pen display. TIP Press the pen nib to the screen firmly to make digital ink appear.
2	Buttons	Use the two buttons as a custom shortcut to a variety of actions. To learn more, see <i>Customizing button actions on the cordless pen</i> on the facing page.
3	Eraser	Turn the pen around and move the eraser over the area you want to erase, just as you would use the eraser on a pencil.

Pen color buttons

This illustration shows the pen color buttons on the side of the interactive pen display.

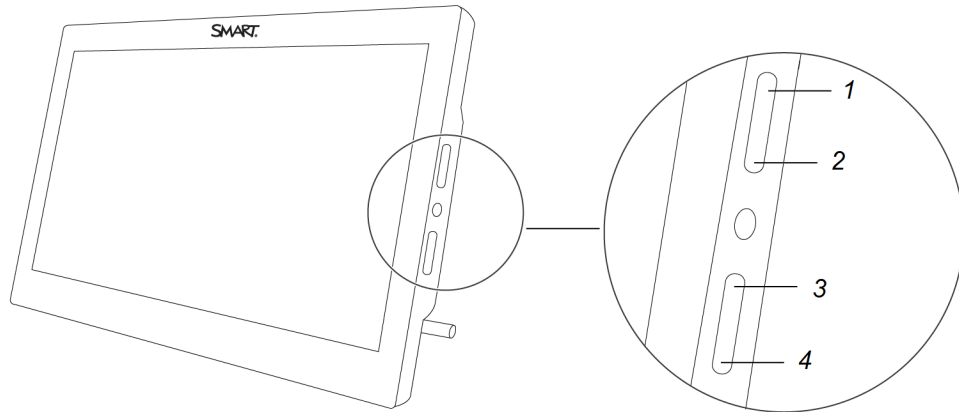

No.	Button	Press this button to:
1	Black ink	Write in black ink.
2	Red ink	Write in red ink.
3	Blue ink	Write in blue ink.



Customizing button actions on the cordless pen

Use SMART Settings to assign and change actions to the buttons on the cordless pen. The assigned action is performed when you press the button on the pen.

Available pen button actions

This table lists the actions you can assign to the buttons on the cordless pen.

Action	Description
Print page	Prints the page currently displayed on the screen
Next page	Moves to the next page in a file.
Previous page	Moves to the previous page in a file
Clear screen	Clears all digital ink and unlocked objects from a page
Right-click	Performs a right-click or control-click on the screen
Middle-click	Performs a middle-click

Action	Description
Double-click	<p>Performs a double-click</p> <hr/> <p> TIP</p> <p>For easier double-clicking, assign this setting to a component, such as a pen button, instead of tapping twice with the pen nib.</p> <hr/>
Floating mouse	<p>Moves the mouse cursor to the pen's tip location without clicking (for example, to "hover" over an item on-screen to reveal a Tool Tip)</p>
SMART keyboard	<p>Launches the SMART on-screen keyboard</p>
SMART Notebook software	<p>Launches SMART Notebook software</p> <hr/> <p> NOTE</p> <p>This option is only available when SMART Notebook software is installed on the connected computer.</p> <hr/>
Screen capture toolbar	<p>Opens the screen capture toolbar</p>
Eraser	<p>The pen nib becomes an eraser until the assigned button is released</p> <hr/> <p> TIP</p> <p>You can also access <i>SMART Hardware Settings</i> to customize the eraser thickness. See <i>Using the cordless pen</i> on page 23</p> <hr/>
Pen	<p>Switches the cordless pen to operate in a customized mode until the assigned button is released</p> <hr/> <p> TIP</p> <p>You can also access <i>SMART Hardware Settings</i> to customize the cordless pen's line style, fill effects and object transparency. See <i>Assigning button actions on the cordless pen</i> below.</p> <hr/>
Disabled	<p>No action is assigned to the button</p>

Assigning button actions on the cordless pen

Use the following procedure to access SMART Hardware Settings and assign actions to the cordless pen's buttons.

▶ **To assign button actions on the cordless pen**

1. Click the **SMART software** icon  in the notification area (Windows computers) or the Dock (Mac computers), and then select **Control Panel**.

OR

Press the **SMART Meeting Pro** icon  in the notification area, and then select **Control Panel**.

SMART Settings appears.

2. Click **SMART Hardware Settings**.
3. Select **Pen and Button settings** from the drop-down list.
4. From the on-screen options, select the button you want to customize.
5. Select an action for the button.
6. Click **APPLY** to save your settings.
7. Click **OK** to close SMART Settings.

Writing or drawing digital ink

You can use the cordless pen to write or draw over SMART Notebook software, SMART Meeting Pro software and other programs using SMART Ink. When you write or draw in an application or on the desktop, the digital ink becomes an object that you can erase, move, and manipulate in a variety of ways.

When you write in a SMART Notebook software or SMART Meeting Pro software, the digital ink becomes part of the file.

NOTES

- By default, SMART Ink starts when you first log on to your computer. If SMART Ink isn't running, you can start it manually. To learn more, see *Working with SMART Ink* on page 31.
 - The interactive pen display ignores a palm resting on the screen.
 - If you are writing or drawing in a Microsoft Office application, see *Using SMART Ink with Microsoft Office* on page 34.
-

▶ **To write or draw digital ink**

1. Pick up the cordless pen.
2. Write or draw on the screen to make notes and draw over your desktop and programs.

 **NOTES**

- Press an ink color side button to select an ink color (see *Pen color buttons* on page 25.)
 - You can also press the SMART Ink dynamic toolbar icon  and use the toolbar commands to customize the pen colors and line thickness, convert handwriting to text, take screen captures and use favorites. To learn more, see *Working with SMART Ink* on page 31.
-

Erasing digital ink

Use the eraser end of the cordless pen to erase the digital ink on the interactive pen display.

▶ **To use the cordless pen to erase digital ink**

Turn the pen around and move the eraser over the area you want to erase.

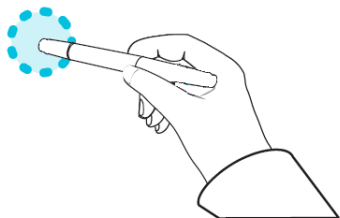

 **NOTE**

You can also use the pen nib as a customizable eraser by using SMART Settings to assign an eraser action to one of the pen buttons. See *Customizing button actions on the cordless pen* on page 25.

Using gestures

By touching the interactive pen display's surface, you can do everything on the display through touch that you can do at your computer by using the keyboard or mouse. You can also use an array of gestures within applications.

Using single finger gestures

You can perform some gestures using one finger, including selecting an object and double-clicking. Single finger gestures include the following:

 **NOTE**

Not all gestures work in all applications. Refer to an application's documentation to learn which gestures it supports.

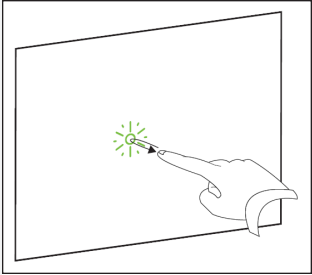
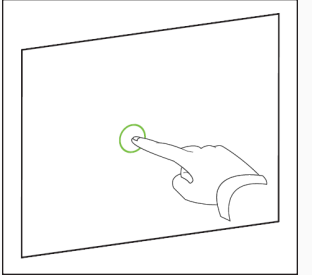
Action	Description	Gesture
Selecting an object (clicking)	Quickly tap the interactive surface to select an object or option. Tap again to cancel the selection. This performs a standard mouse click.  NOTE This gesture starts applications if your computer's operating system is set to start applications with single click.	
Displaying menu options (right-clicking)	Tap and hold the screen with your finger. In SMART Notebook software, Windows and Microsoft Office programs, the right-click menu appears.	

Double-clicking Quickly Tap the interactive surface twice in the same spot. This performs a standard double-click.

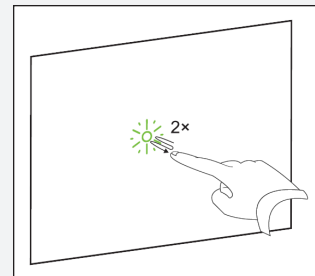

Dragging an object or scroll bar Tap and hold an object or scroll bar on the screen. Slowly move your finger on the screen to move the object or scroll bar. When you reach the position you want, release your finger.

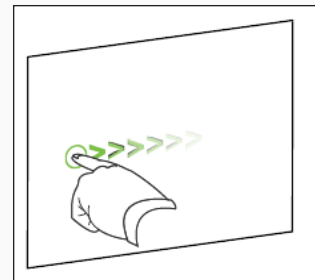

Using multi-finger gestures

You can perform some gestures using two or more fingers, including zooming, scaling, scrolling and manipulating objects. Multi-finger gestures include:

NOTE

Not all gestures work in all applications. Refer to an application's documentation to learn which gestures it supports.

Action	Description	Gesture
Zoom in, enlarge	Place one finger on each hand in the center of the area or object, and then drag your fingers away from each other.	

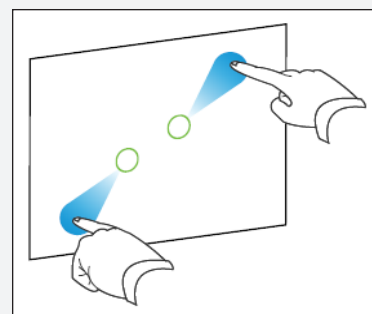

Zoom out,
shrink

Place one finger on each hand on the screen at opposite ends of the area or object, and then drag your fingers toward each other.

This gesture scales an object on a page or the entire page, depending on the application.

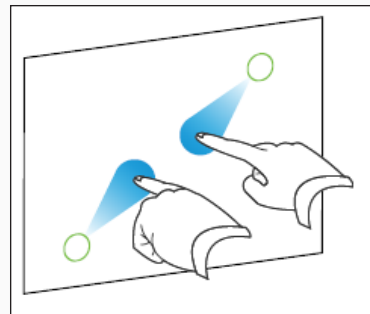

Rotating an
object in place

Place one finger on either side of the object you want to rotate. Keep one finger in place and move your second finger around the object. Release your fingers from the screen when you're satisfied with the angle.

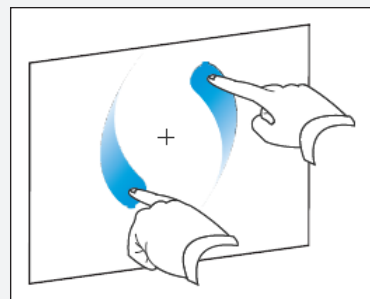

 **NOTE**

- Not all gestures work in all applications. Refer to an application's documentation to learn which gestures it supports.
- Placing your fingers together too closely might be interpreted as a single finger.

Working with SMART Ink

The SMART Podium interactive pen display comes with SMART Learning Suite (including SMART Notebook) or SMART Meeting Pro software (see *Chapter 3: Installing SMART software* on page 19). Both feature SMART ink, which enables you to use the cordless pen or your finger to add notes or drawings to presentations on the touch screen.

By default, SMART Ink starts when you first log on to your computer. However, if SMART Ink isn't set up to start automatically, you can start it manually. See *Starting SMART Ink manually* on the next page.

After SMART Ink starts, you can open the SMART Ink dynamic toolbar and use it to write and draw, convert handwriting to text, take screen captures and use favorites.

 **NOTE**

- If you start SMART Ink manually but your computer isn't connected to a SMART interactive product, a notification appears.
 - Although the dynamic toolbar works with the desktop and all applications, some of its options vary from application to application.
-

Starting SMART Ink manually

If SMART Ink isn't set up to start automatically, you can use the following procedure start it manually.

To start SMART Ink manually in Windows

In Windows 7, select **Start > All Programs > SMART Technologies > SMART Ink**.

OR

In Windows 8.1, go to the *Apps* screen, and then scroll to and select **SMART Technologies > SMART Ink**.

OR

In Windows 10, select **Start > All apps**, and then scroll to and select **SMART Technologies > SMART Ink**.

To start SMART Ink manually in OS X operating system software

In Finder, go to **Applications > SMART Technologies** and double-click **SMART Ink**.

Using the dynamic toolbar

The dynamic toolbar, shown below, appears when SMART Ink starts. Opening the dynamic toolbar in full mode lets you access additional features that enhance the notes and drawings you create in digital ink.

Although the dynamic toolbar works with the desktop and all applications, some of the options it presents vary from application to application.



If the dynamic toolbar is covering something you want to see, drag it to a different part of the screen.

► **To open the dynamic toolbar in full mode**

Tap the dynamic toolbar to open it in full mode.

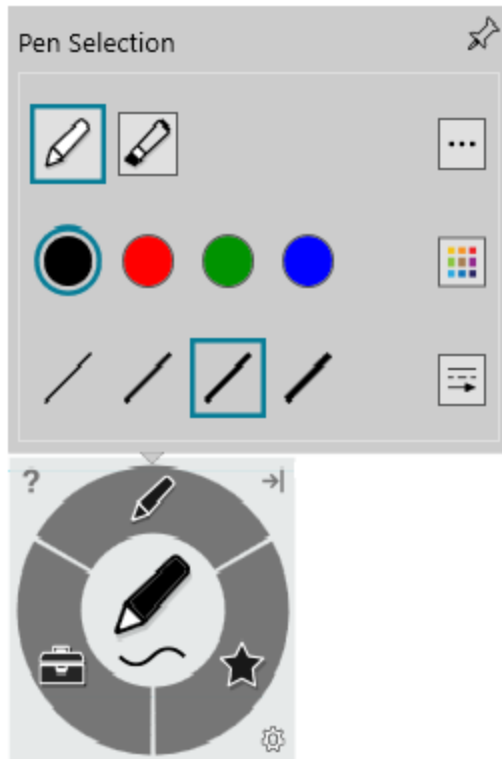

 **NOTE**

The toolbar minimizes after 10 seconds of non-use. You can also minimize the toolbar at any time by tapping its center.

► **To move and dock the dynamic toolbar**

You can move the dynamic toolbar to the left or right edge of the screen and dock it there by dragging it to that edge. You can also tap the docking button in the top-right corner of the dynamic toolbar.

About SMART Ink settings

You can use the *SMART Ink Settings* window to change a number of settings for SMART Ink, including:

- General settings
- Dynamic toolbar settings
- Microsoft Office settings

NOTE

If you're using SMART Ink on Windows, you can also use the SMART Ink Settings window to troubleshoot common issues.

For more information about accessing and changing SMART Ink Settings, see the *Changing SMART Ink 5 Settings* support site page at support.smarttech.com/docs/software/ink/ink-5/en/installing-and-maintaining/changing-settings.

Using SMART Ink with Microsoft Office

SMART Ink includes plug-ins that enable you to use the software with Microsoft Office applications.

NOTE

This section applies to Windows only.

Microsoft Word, Excel® and PowerPoint have their own ink tools which you can enable in SMART Ink Settings. For more information, see *Changing settings in Windows operating systems* on the Changing SMART Ink 5 Settings support site page at support.smarttech.com/docs/software/ink/ink-5/en/installing-and-maintaining/changing-settings.

This table compares Microsoft's ink tools and SMART Ink:

Category	Microsoft's ink tools	SMART Ink
Purpose	Reviewing or making changes to a document	Highlighting important notes or drawing attention to content in a document
Capturing ink	Ink is inserted directly into a document.	Ink is captured in a transparent layer over a document.
Saving ink	The inserted ink is saved with the document.	Take a screen capture and save it using SMART software.

Writing or drawing in PDF files

You can write or draw in PDF files using the following tools:

- SMART Ink plugin for Adobe Acrobat® Reader (Windows only)
- SMART Ink Document Viewer

With Adobe Acrobat Reader and the SMART Ink plugin, you can write, draw and erase digital ink in PDF files. The SMART Ink plugin inserts digital ink in the PDF file as Adobe Acrobat Reader comments.

For more information on using the features of SMART Ink with Adobe Acrobat Reader, see *Using the SMART Ink 5.1 plugin for Adobe Acrobat Reader* support site page at support.smarttech.com/docs/software/ink/ink-5/en/using/using-the-smart-ink-plugin/default.cshtml.

Other SMART Ink resources

For more information about using the features and configuration options available in SMART Ink, refer to the *SMART Ink 5* support site pages at support.smarttech.com/software/other-software/smart-ink/ink-5.